

METRIC FITTING SHIMS 3-SLOT

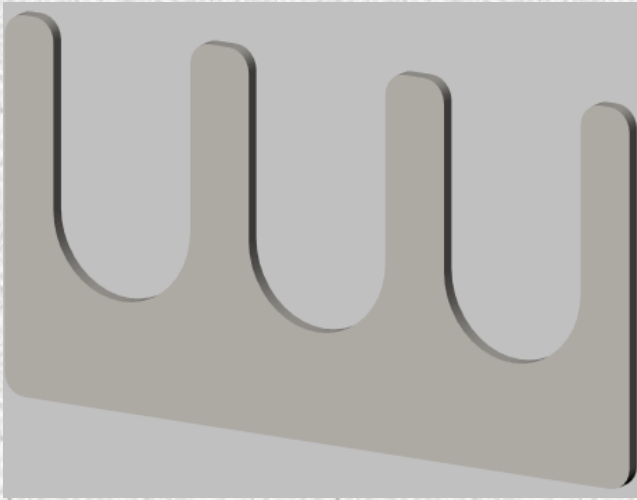

CODE	A	SURFACE
ASH502	0.25	NONE
ASH505	0.50	YELLOW ZINC DICHROMATE.
ASH510	1.00	BLACK OXIDE
ASH520	2.00	NONE

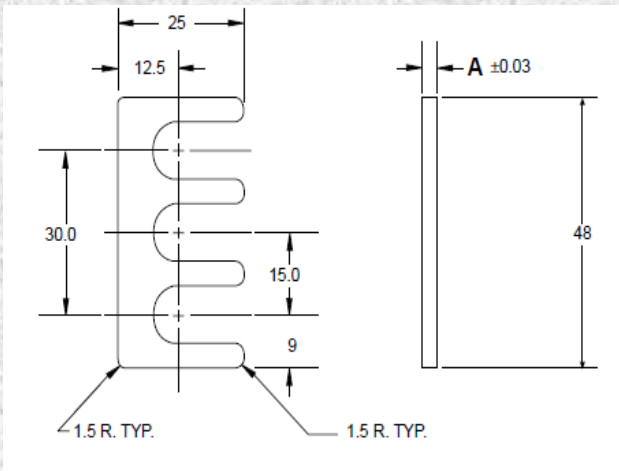

SHIM PACK ASH3	
QTY.	CODE
2	ASH302
3	ASH305
1	ASH310
1	ASH320

METRIC DIMENSIONAL TOLERANCES UNLESS OTHERWISE SPECIFIED

0 PLACE+0.5 1 PLACE+0.3 MATERIAL: SAE 1010

